

변경 사항			
기호	변경 내용	날짜	수정 승인
△			
△			

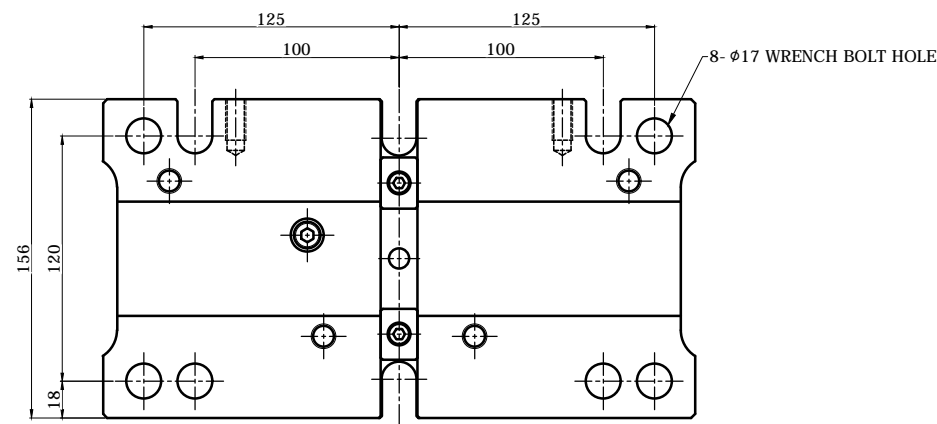

SPECIFICATIONS	
Center Height [mm]	185
Thru Hole Diameter [mm]	φ70
Clamp Method	Pneumatic
Max Pressure	5~7 kgf/cm ²
Clamp Torque [N.m]	-
Weight [kg]	50

TITLE	Tail Spindle (Pneumatic)	PART NAME	외 형 도
DRG. NO.	25SP- MA- 00	USER	-
CODE NO.	-	DEPARTMENT	Research & Development
SCALE	1 : 1	DATE	2021. 05. 01
	Approved	Checked	Designed

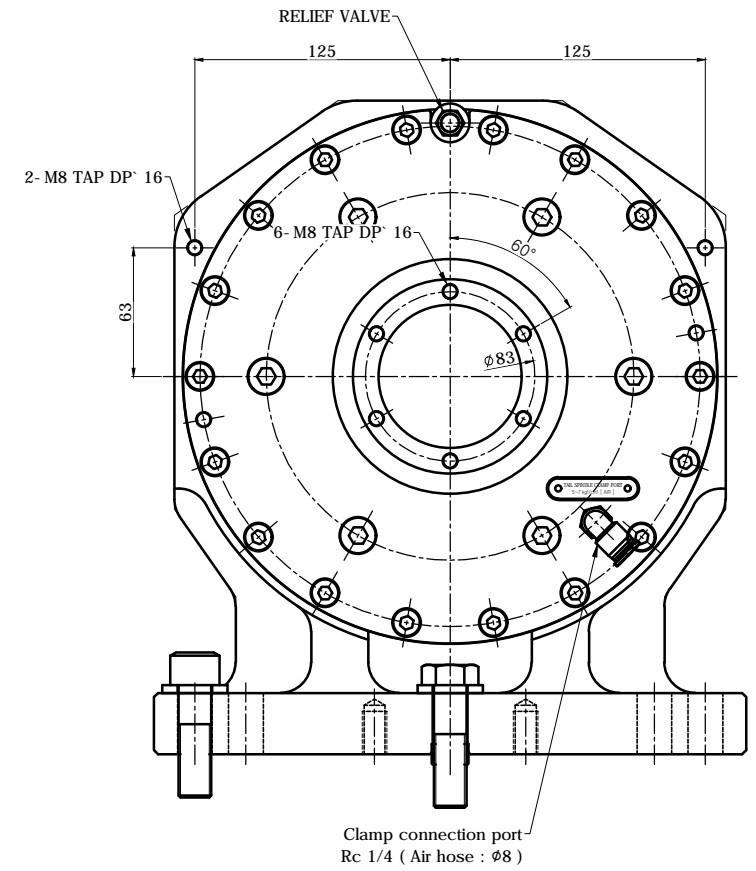
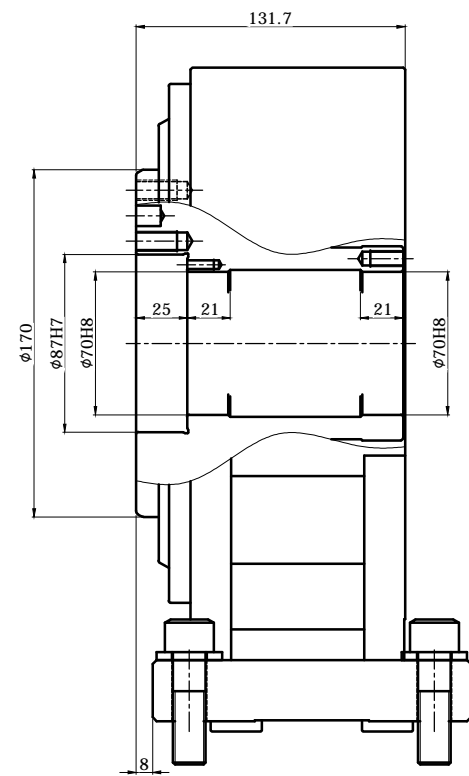
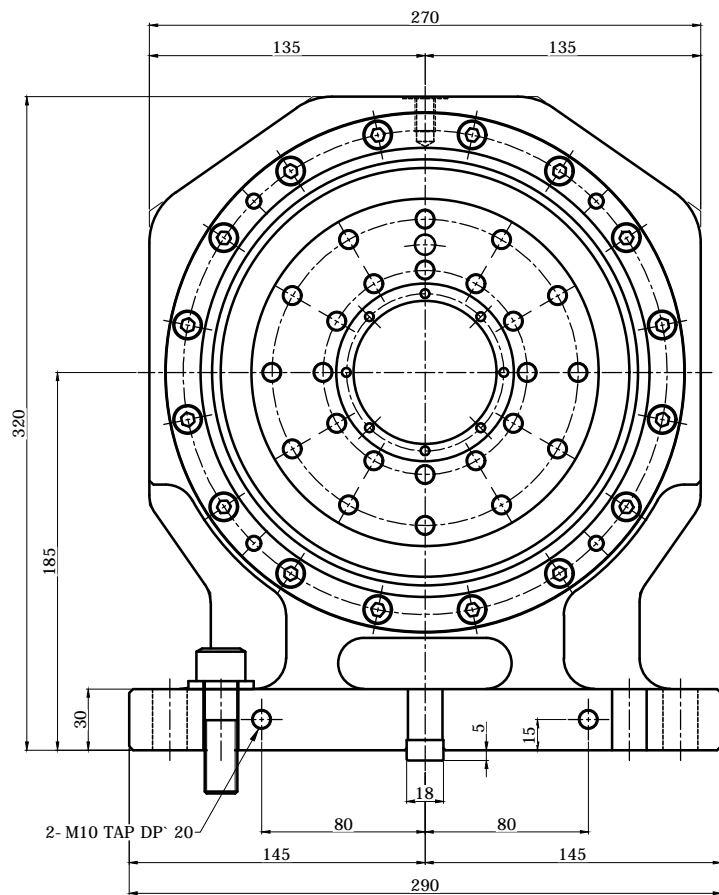
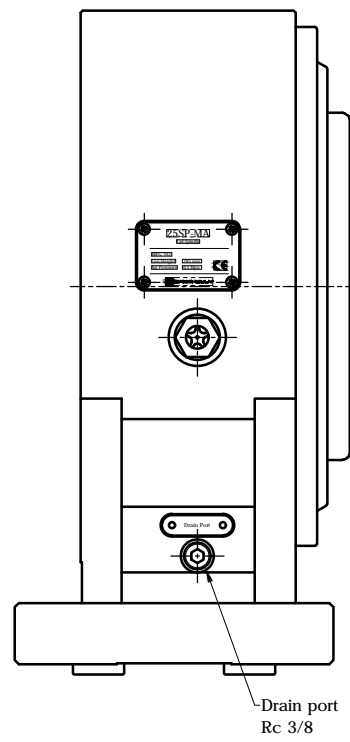
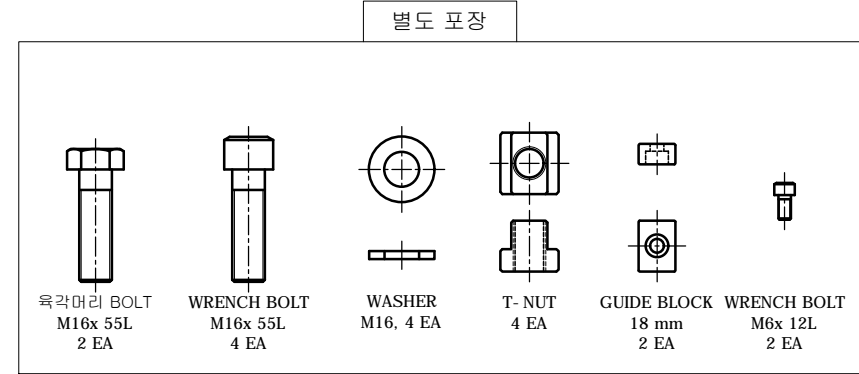
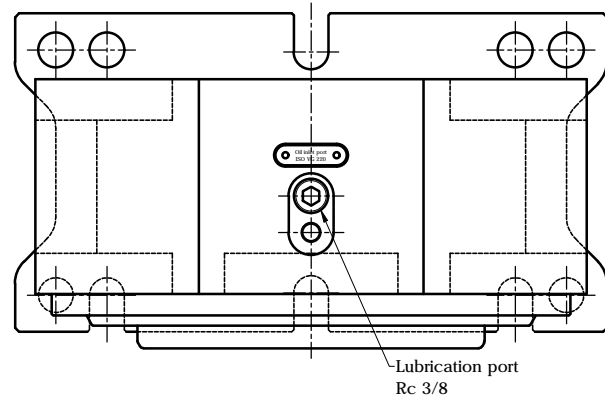
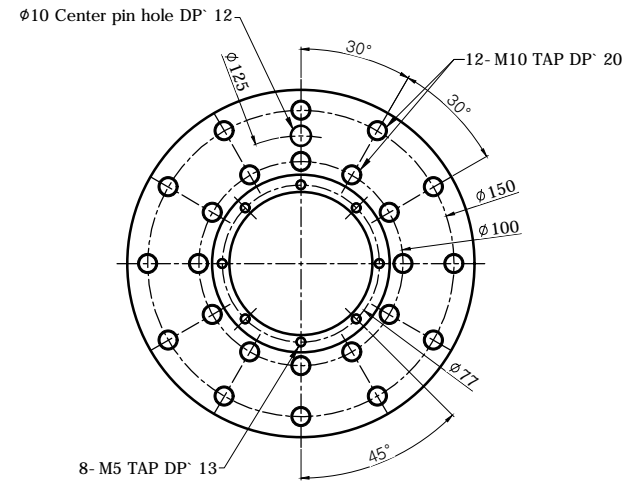